

REV	DESCRIPTION	BY	APPR
H	REVISED PER ECR# 6003	C.W.B.	W.P.M.
		09/16/99	

NOTES:

- REF - WIRE STRIP LENGTH TO BE .187/4.75.
- CRIMP CONTACTS AVAILABLE ON REELS (2000/REEL). SEE CHART FOR REEL PART NO.
- CATALOG NUMBER CODE:



100 SERIES CODE ORDER CHART

- SERIES CODE: 100 - *****
- CONTACT PLATING (OMIT FOR STANDARD) OTHER FINISHES AVAILABLE UPON REQUEST. CONSULT SALES DEPARTMENT
- CONTACT TYPE: P = PIN, PK = PIN, S = SOCKET
- Socket Contact
Material: Copper Alloy
Finish: Standard= 8 μ /0.2 μ m Min Gold Over Nickel
Military= 50 μ /1.25 μ m Min Gold Over Nickel
 - Pin Contact
Material: Copper Alloy
Finish: Standard= 8 μ /0.2 μ m Min Gold Over Nickel
Military= 50 μ /1.25 μ m Min Gold Over Nickel
 - Retainer Clip
Material: Standard= Beryllium Copper Alloy
Finish: Gold Plated
 - Contact Spring
Material: Beryllium Copper Alloy
Finish: Standard= Nickel Plated
Military= Gold Plated
 - Contact Spring
Material: Beryllium Copper Alloy
Finish: Gold Plated

PERFORMANCE CHARACTERISTICS

Conforms to MIL-C-39029

Current rating 7.5 amps, max. for 0.040/102 per individual contact
13 amps, max. for 0.0625/1587 per individual contact

ACCESSORY TOOLS

DESCRIPTION	CATALOG NO	LOCATORS/POSITIONERS	CRIMP DEPTH BLOCK	SPANNER WRENCH
INSERTION TOOL	107-1015			
REMOVAL TOOL	107R-1001			
REMOVAL TOOL	107-1005			
NON-ADJUSTABLE HAND CRIMP MS-3191-2	107-0970	107-0981 (#14) 107-0977 (#16,#18) 107-0976 (#20,#22,#24,#26)		
HAND CRIMP	107-0903-2A	107-0945		107-1102
PNEUMATIC AUTOMATIC CRIMP	107-0961		107-0965-#20 107-0966-#16	
NON-ADJUSTABLE MINIATURE HAND CRIMP	107-43300	107-43304		
ADJUSTABLE MINIATURE HAND CRIMP	107-0625	107-0993 (#20,#22,#24,#26) 107-0628		
CONTACT PIN STRAIGHTENER	107-1024			
GAGE PLUG	5431			

SPECIFICATIONS

MATERIALS & FINISHES

PER ANSI Y14.5M-1987 UNLESS OTHERWISE SPECIFIED: DIMENSIONS ARE IN INCHES OR INCHES / MM

TOLEANCES: .XX \pm .02, .XXX \pm .010

ANGLES: SCALE: 5:1

CUSTOMER DRAWING

DATE DRAWN: 03/28/96 | W.P.M. | DATE: 03/29/96

DATE APPROVED: 03/28/96 | R.D.R. | DATE: 03/29/96

TITLE: MRAC REMOVABLE PIN & SOCKET CONTACTS

Winchester Electronics | 400 PARK ROAD | WATERBURY, CONNECTICUT 06795

REV. 1 of 5

22891

C

REFORMATED BY FEI 01/05/98

REV	DESCRIPTION	BY	DATE
H	REVISED PER ECR# 6003	C.W.B.	09/16/99
		W.P.M.	

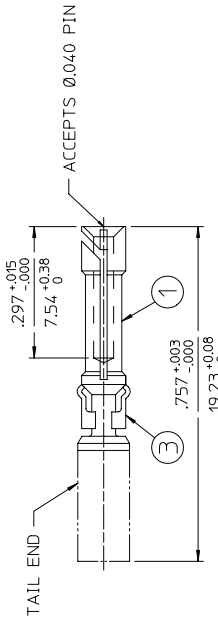
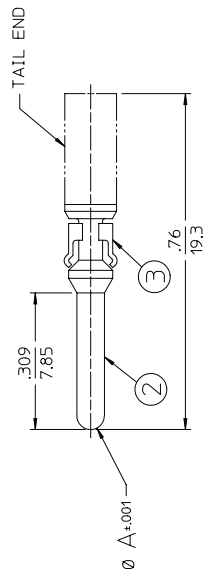

PIN

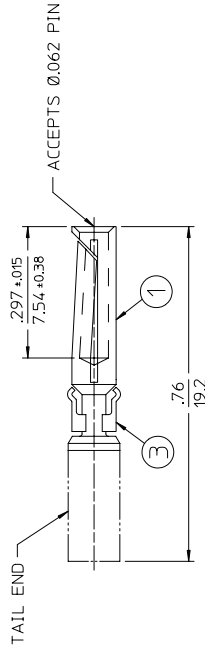

TAIL OPTIONS

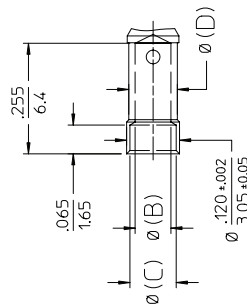

CRIMP

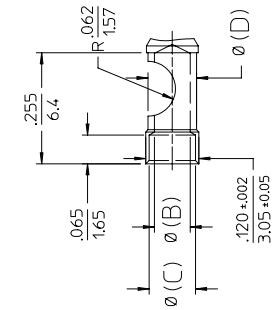

SOLDER

2 PIECE SOCKETS

PIN Ø A = .0625/1587				PIN Ø A = .040/102			
CRIMP CAT. NO	REEL	CONTACT	SOLDER CAT. NO	REEL	CONTACT	WIRE SIZE	
100-1026P-Δ	100-0963P-Δ	100-0951P-Δ	100-2024P-Δ	100-0951P-Δ	100-2624P-Δ	26-28-30	.050/1.27
100-1024P-Δ	100-0917P-Δ	100-2524P-Δ	100-2022P-Δ	100-0947P-Δ	100-2622P-Δ	24-26-28	.055/1.40
100-1022P-Δ	100-0907P-Δ	100-2522P-Δ	100-2020P-Δ	100-0945P-Δ	100-2620P-Δ	22-24-26	.055/1.40
100-1020P-Δ	100-0915P-Δ	100-2520P-Δ	100-2018P-Δ	100-0943P-Δ	100-2618P-Δ	20-22-24	.069/1.75
100-1018P-Δ	100-0913P-Δ	100-2518P-Δ	100-2016P-Δ	100-0941P-Δ	100-2616P-Δ	18-20-22	.078/1.98
100-1016P-Δ	100-0911P-Δ	100-2516P-Δ				16-18-20	.094/2.39
100-1014P-Δ	100-0909P-Δ	100-2514P-Δ				14-16-18	.105/2.67
100-1012P-Δ	100-0907P-Δ					12-14	.120/3.05
100-1026S-Δ	100-0965S-Δ					26-28-30	.050/1.27
100-1024S-Δ	100-0927S-Δ	100-2524S-Δ	100-2024S-Δ	100-0941S-Δ	100-2624S-Δ	24-26-28	.055/1.40
100-1022S-Δ	100-0908S-Δ	100-2522S-Δ	100-2022S-Δ	100-0937S-Δ	100-2622S-Δ	22-24-26	.055/1.40
100-1020S-Δ	100-0925S-Δ	100-2520S-Δ	100-2020S-Δ	100-0935S-Δ	100-2620S-Δ	20-22-24	.069/1.75
100-1018S-Δ	100-0923S-Δ	100-2518S-Δ	100-2018S-Δ	100-0933S-Δ	100-2618S-Δ	18-20-22	.078/1.98
100-1016S-Δ	100-0921S-Δ	100-2516S-Δ	100-2016S-Δ	100-0931S-Δ	100-2616S-Δ	16-18-20	.094/2.39
100-1014S-Δ	100-0919S-Δ	100-2514S-Δ				14-16-18	.105/2.67

PER ANSI Y14.5M-1987
UNLESS OTHERWISE SPECIFIED:
DIMENSIONS ARE IN INCHES
TOLERANCES
INCHES / MILLIMETERS
XX ± .02
XXX ± .010
SCALE: 5:1

Litton
Winchester Electronics

400 PARK ROAD
WATERLOON, CONNECTICUT
06495

CUSTOMER DRAWING

MRC REMOVABLE
PIN & SOCKET CONTACTS

DATE APPROVED 05/18/94	DATE INCHES / MILLIMETERS 08/18/94	SCALE 5:1	REV. H
APPROVED V.B.H.	DATE APPROVED 08/18/94	DR. DR.	REV. H
DATE APPROVED 05/18/94	DATE INCHES / MILLIMETERS 08/18/94	SCALE 5:1	REV. H
APPROVED V.B.H.	DATE APPROVED 08/18/94	DR. DR.	REV. H

DATE APPROVED 05/18/94	DATE INCHES / MILLIMETERS 08/18/94	SCALE 5:1	REV. H
APPROVED V.B.H.	DATE APPROVED 08/18/94	DR. DR.	REV. H

DATE APPROVED 05/18/94	DATE INCHES / MILLIMETERS 08/18/94	SCALE 5:1	REV. H
APPROVED V.B.H.	DATE APPROVED 08/18/94	DR. DR.	REV. H

REV	DESCRIPTION	DATE	BY
H	REVISED PER ECR# 6003	09/16/99	W.P.M.

3 PIECE SOCKET

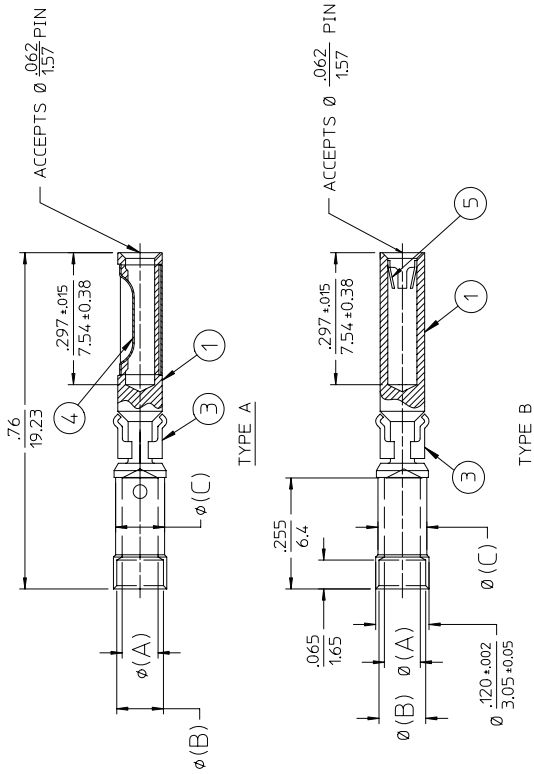

CATALOG NO	REEL CAT. NO	WIRE SIZE	A	B	C	TYPE	
100-51014S-Δ	100-0981S-Δ	14-16-18	.081/2.06	.105/2.67	.110/2.79	A	
100-51016S-Δ	100-0982S-Δ	16-18-20	.067/1.70	.094/2.39			
100-51018S-Δ	100-0983S-Δ	18-20-22	.052/1.32	.078/1.98	.096/2.44		
100-51020S-Δ	100-0984S-Δ	20-22-24	.045/1.14	.067/1.70			
100-51022S-Δ	100-0985S-Δ	22-24-26	.033/0.84		.077/1.95		
100-51024S-Δ	100-0986S-Δ	24-26-28	.027/0.68				
100-51026S-Δ	100-0987S-Δ	26-28-30	.024/0.61	.050/1.27			
100-61014S-Δ	100-8024S-Δ	14-16-18	.081/2.06	.105/2.67	.110/2.79		B
100-61016S-Δ	100-8025S-Δ	16-18-20	.067/1.70	.094/2.39			
100-61018S-Δ	100-8026S-Δ	18-20-22	.052/1.32	.078/1.98	.096/2.44		
100-61020S-Δ	100-8027S-Δ	20-22-24	.045/1.14	.067/1.70			
100-61022S-Δ	100-8028S-Δ	22-24-26	.033/0.84		.077/1.95		
100-61024S-Δ	100-8029S-Δ	24-26-28	.027/0.68				
100-61026S-Δ	100-8030S-Δ	26-28-30	.024/0.61	.050/1.27			

PIN

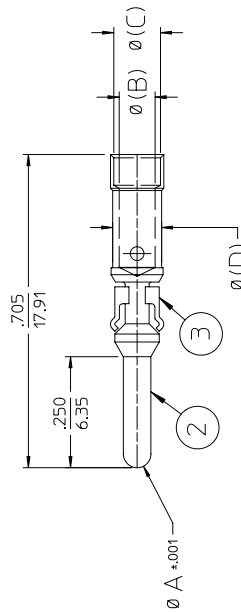

PIN Ø A = .0625/1587		PIN Ø A = .040/102		WIRE SIZE		C		D	
CONTACT	REEL	CONTACT	REEL						
100-1024PK-Δ	100-0976PK-Δ	100-2024PK-Δ	100-0990PK-Δ	24-26-28	.027/0.68	.055/1.40	.110/2.79		
100-1022PK-Δ	100-0975PK-Δ	100-2022PK-Δ	100-0980PK-Δ	22-24-26	.033/0.84	.069/1.75			
100-1020PK-Δ	100-0974PK-Δ	100-2020PK-Δ	100-0988PK-Δ	20-22-24	.046/1.17	.096/2.44			
100-1018PK-Δ	100-0973PK-Δ	100-2018PK-Δ	100-0989PK-Δ	18-20-22	.052/1.32	.078/1.98			
100-1016PK-Δ	100-0972PK-Δ	100-2016PK-Δ	100-0988PK-Δ	16-18-20	.068/1.73	.094/2.39			
100-1014PK-Δ	100-0971PK-Δ			14-16-18	.081/2.06	.105/2.67			

PER ANSI Y14.5M-1987
UNLESS OTHERWISE SPECIFIED:
DIMENSIONS ARE IN INCHES OR INCHES / MM

TOLERANCES
DECIMALS .XX ±.02
XXX ±.010

ANGLES 1 SCALE: 5:1

Littion
Winchester Electronics
400 BARK ROAD
WATERLOO, CONNECTICUT
06795

CUSTOMER DRAWING

DATE CHECKED: 03/28/96 W.P.M.
DATE APPROVED: 03/28/96 R.D.R.
DATE: 03/29/96

TITLE: MRAC REMOVABLE PIN & SOCKET CONTACTS

REV: H
SHEET: 3 OF 5

22891

DATE: 03/29/96

REV	DESCRIPTION	BY	APPR
H	REVISED PER ECR# 6003	C.W.B.	W.P.M.
		09/16/99	

MILITARY PIN & SOCKET ASSEMBLIES

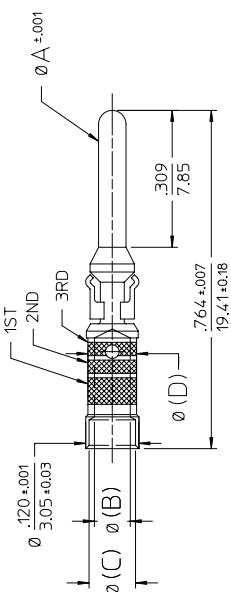

PIN CONTACTS

MILITARY CONTACT CAT. NO	W.E.D. CONTACT CAT. NO	REEL CAT. NO	COLOR BANDS			WIRE SIZE	PIN Ø A	B	C	D	USED IN CONNECTOR SERIES
			1ST	2ND	3RD						
M39029/34-271	100R-2020P95	100R-0945P95	BROWN			20-22-24	.040/1.02	.046/1.17	.069/1.75	.077/1.95	M28748
M39029/34-272	100R-1020P95	100R-0915P95	RED	VIOLET		20-22-24	.0625/1.587	.068/1.73	.094/2.39	.110/2.79	
M39029/34-273	100B-1016P95	100B-0911P95	ORANGE			16-18-20					

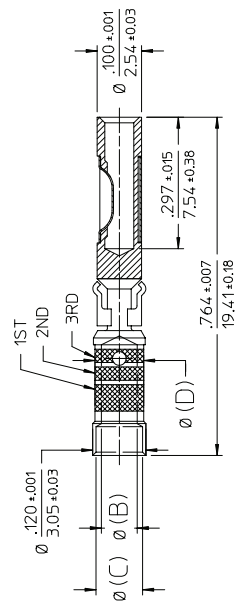

CATALOG NO'S M39029/35-275 & -276 SHOWN

SOCKET CONTACTS

MILITARY CONTACT CAT. NO	W.E.D. CONTACT CAT. NO	REEL CAT. NO	COLOR BANDS			WIRE SIZE	MATING PIN Ø	B	C	D	USED IN CONNECTOR SERIES
			1ST	2ND	3RD						
M39029/35-274	100R-2020S95	100R-0979S95	RED	VIOLET		20-22-24	.040/1.02	.046/1.17	.069/1.75	.077/1.95	M28748
M39029/35-275	100R-51020S95	100R-0984S95	YELLOW	GREEN		20-22-24	.0625/1.587	.068/1.73	.094/2.39	.110/2.79	
M39029/35-276	100B-51016S95	100B-0982S95	BLUE			16-18-20					

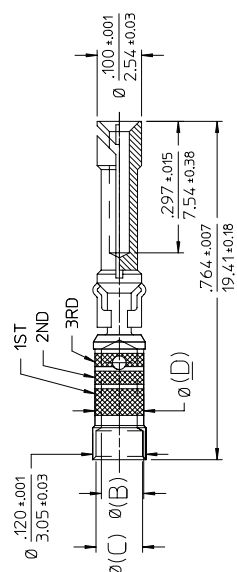

CATALOG NO M39029/35-274 SHOWN

PER ANSI Y14.5M-1987
UNLESS OTHERWISE SPECIFIED:
DIMENSIONS ARE IN INCHES OR INCHES / MM

TOLERANCES
XX ± .02
XXX ± .010
ANGLES ± X°

SCALE: 5:1

Litton
Winchester Electronics
400 PARK ROAD
WATERDOWN, CONNECTICUT
06795

CUSTOMER DRAWING

TITLE: MRAC REMOVABLE PIN & SOCKET CONTACTS

DATE DRAWN: K.D.B. 03/28/96	DATE CHECKED: W.P.M. 03/29/96
DATE APPROVED: V.B.H. 03/28/96	DATE APPROVED: R.D.R. 03/29/96

REV. 5 of 5

22891

C

REV	DESCRIPTION	DATE	BY	APPD
H	REVISED PER ECR# 6003	09/16/99	C.W.B.	W.P.M.

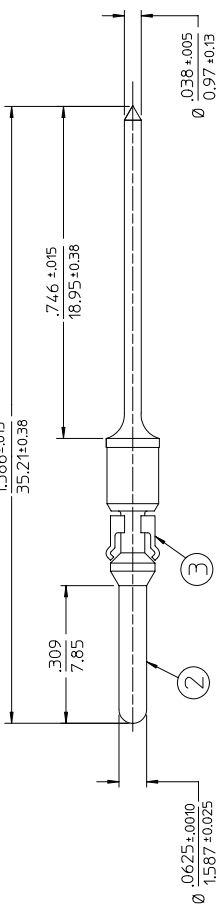

CATALOG NO 7130 SHOWN

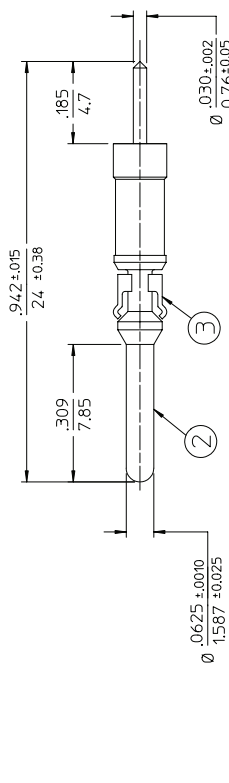

CATALOG NO 8124-Δ SHOWN

DIP SOLDER CONTACTS

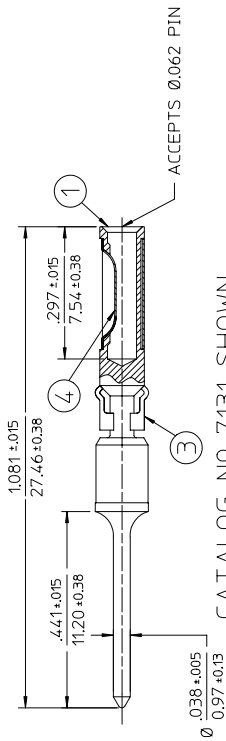

CATALOG NO 7131 SHOWN

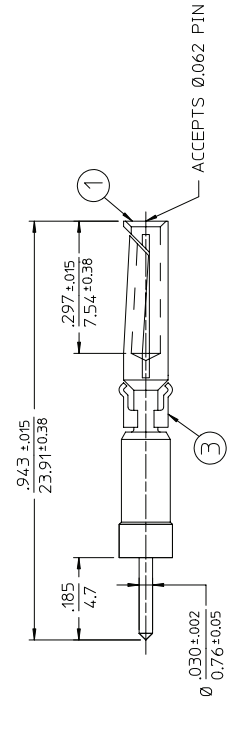

CATALOG NO 8125-Δ SHOWN

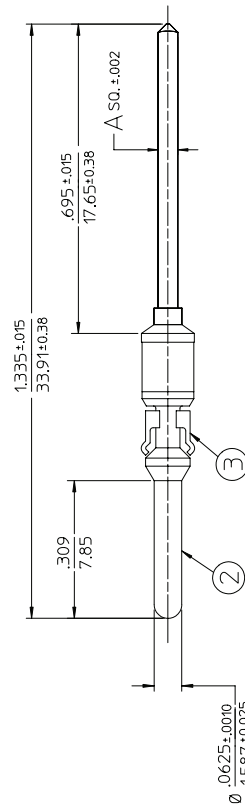

CATALOG NO'S 8106-Δ AND 8114-Δ SHOWN

CAT. NO	A
8106-Δ	.045/1.43 SO.
8114-Δ	.025/0.64 SO.

WIRE WRAP CONTACTS

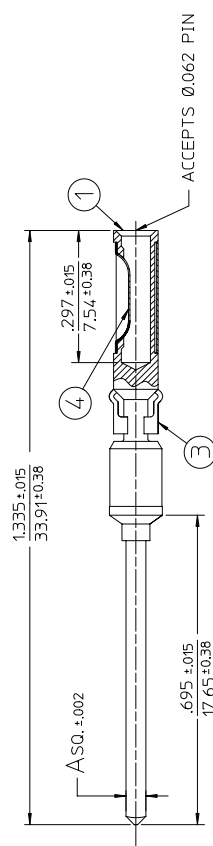

CATALOG NO'S 8105-Δ AND 8113-Δ SHOWN

CAT. NO	A
8105-Δ	.045/1.43 SO.
8113-Δ	.025/0.64 SO.

PER ANSI Y14.5M-1987 UNLESS OTHERWISE SPECIFIED: DIMENSIONS ARE IN INCHES / MM
 TOLERANCES: XX ± .02, XXX ± .010
 ANGLES: 1

SCALE: 5:1

Litton
 Winchester Electronics
 605 BUSH ROAD
 WATERBURY CONNECTICUT
 06795

CUSTOMER DRAWING

DATE CHECKED	DATE
K.D.B. 03/28/96	W.P.M. 03/29/96
DATE APPROVED	DATE
V.B.H. 03/28/96	R.D.R. 03/29/96

TITLE: MRAC REMOVABLE PIN & SOCKET CONTACTS

REV.	REV.
5	H

22891

5 of 5

REFORMATTED BY FEV 01/05/98