

EZ Form SMA

Non-Magnetic Connectors

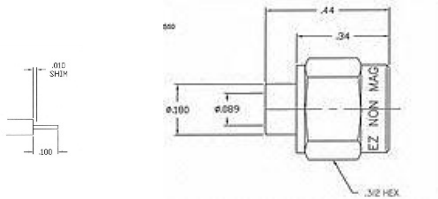

**Straight Plug with
Retractable Nut and
Solder On Contact for
.086 Dia. Semi-Rigid**

Part Number

705522-308

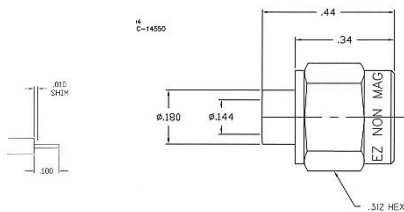

**Straight Plug with
Retractable Nut and
Solder On Contact for
.141 Dia. Semi-Rigid**

Part Number

705533-602

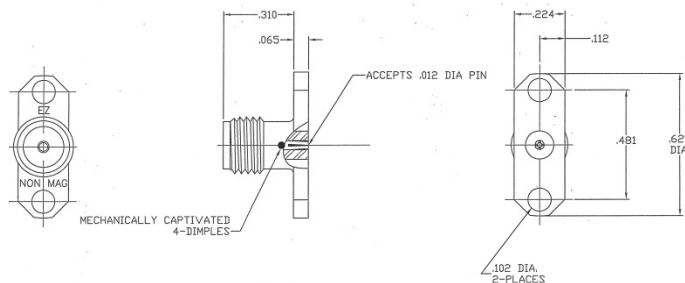

**Flange Mount Jack
Receptacle, Double
Ended Female
Contact**

Part Number

705971-801

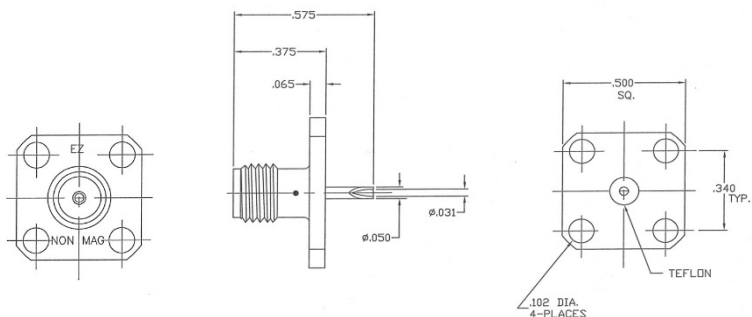

**Flange Mount Jack
Receptacle, Solder Pot
Contact**

Part Number

705615-801

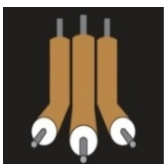

EZ Form Cable Corporation
285 Welton Street, Hamden, CT 06517
Tel: (203) 785-8215 Fax: (203) 785-0466

www.ezform.com

EZ Form SMA

Non-Magnetic Connectors

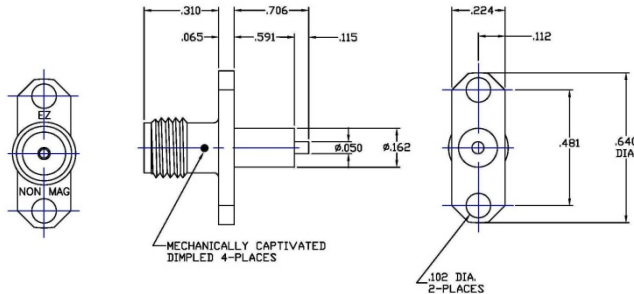

Flange Mount Jack Receptacle .050 Dia. Contact

Part Number

705626-301

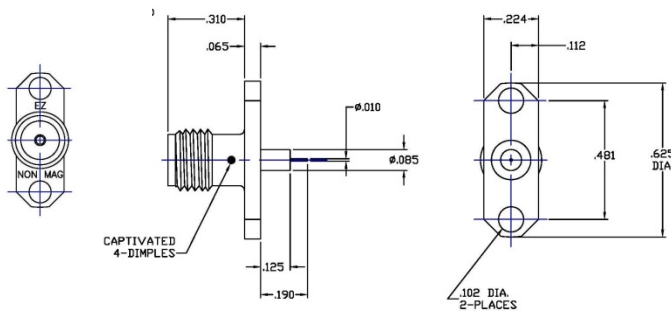

Flange Mount Jack Receptacle, .010 Dia. Contact

Part Number

705626-116

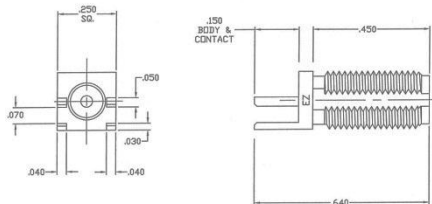

Bulkhead Mount Printed Circuit Board Jack

Part Number

705433-801

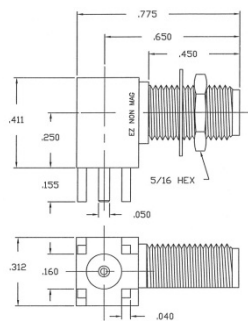

Right Angle Bulkhead Mount Printed Circuit Board Jack

Part Number

705102-801

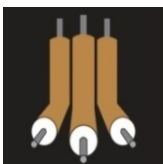

EZ Form Cable Corporation
285 Welton Street, Hamden, CT 06517
Tel: (203) 785-8215 Fax: (203) 785-0466

www.ezform.com

EZ Form SMA

Non-Magnetic Connectors

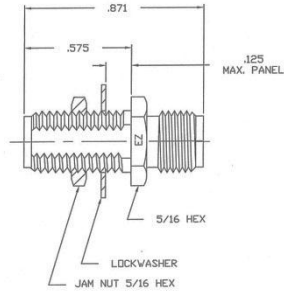

**Bulkhead Mount Jack to
Plug Adapter**

Part Number

705628-801

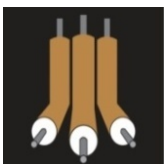

EZ Form Cable Corporation
285 Welton Street, Hamden, CT 06517
Tel: (203) 785-8215 Fax: (203) 785-0466

www.ezform.com